

DUAL OPERATIONAL AMPLIFIER

■ GENERAL DESCRIPTION

The NJM4558/4559 integrated circuit is a dual high-gain operational amplifier internally compensated and constructed on a single silicon chip using an advanced epitaxial process.

Combining the features of the NJM741 with the close parameter matching and tracking of a dual device on a monolithic chip results in unique performance characteristics. Excellent channel separation allows the use of the dual device in single NJM741 operational amplifier applications providing density. It is especially well suited for applications in differential-in, differential-out as well as in potentiometric amplifiers and where gain and phase matched channels are mandatory.

■ FEATURES

- Operating Voltage ($\pm 4V \sim \pm 18V$)
- High Voltage Gain (100dB typ.)
- High Input Resistance ($5M\Omega$ typ.)
- Bipolar Technology
- Package Outline
 DIP8, DMP8, SIP8
 SOP8 JEDEC 150mil (only NJM4558),
 SSOP8 (only NJM4558)

■ PACKAGE OUTLINE

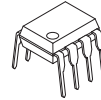

**NJM4558D
NJM4559D
(DIP8)**



**NJM4558M
NJM4559M
(DMP8)**



**NJM4558V
(SSOP8)**

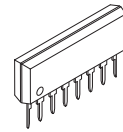

**NJM4558L
NJM4559L
(SIP8)**



**NJM4558E
(SOP8)**

■ PIN CONFIGURATION

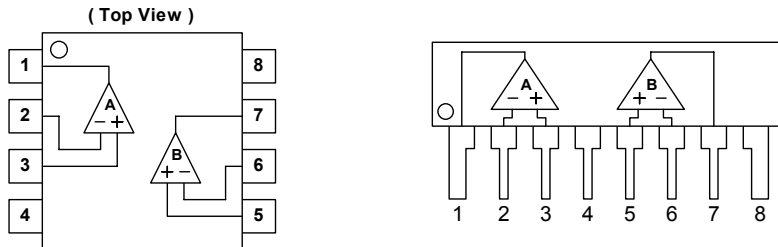

**NJM4558D, NJM4558M, NJM4558E, NJM4558V
NJM4559D, NJM4559M**

**NJM4558L
NJM4559L**

PIN FUNCTION

1. A OUTPUT
2. A - INPUT
3. A + INPUT
4. V^-
5. B + INPUT
6. B - INPUT
7. B OUTPUT
8. V^+

■ EQUIVALENT CIRCUIT (1/2 Shown)

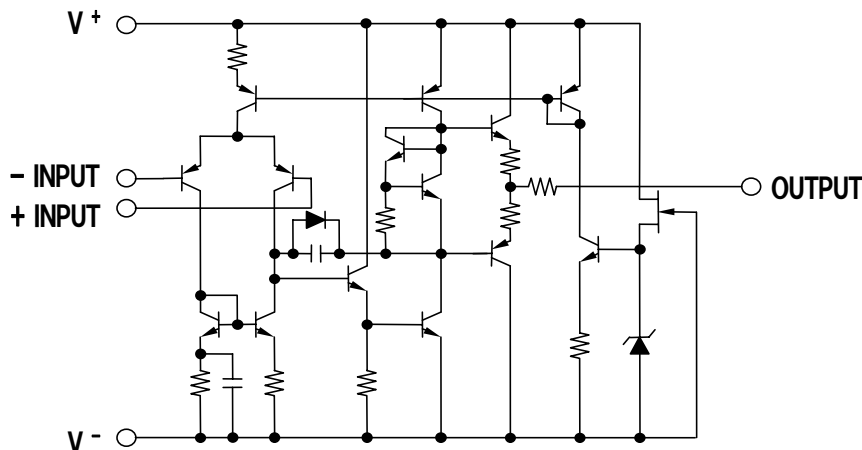

NJM4558/4559

■ ABSOLUTE MAXIMUM RATINGS

(Ta=25°C)

PARAMETER	SYMBOL	RATINGS	UNIT
Supply Voltage	V ⁺ /V	± 18	V
Differential Input Voltage	V _{ID}	± 30	V
Input Voltage	V _{IC}	± 15 (note1)	V
Power Dissipation	P _D	(DIP8) 500 (DMP8) 300 (SOP8) 300 (SSOP8) 250 (SIP8) 800	mW
Operating Temperature Range	T _{opr}	-40~+85	°C
Storage Temperature Range	T _{stg}	-40~+125	°C

(note1) For supply voltage less than ±15V, the absolute maximum input voltage is equal to the supply voltage.

■ ELECTRICAL CHARACTERISTICS

(V⁺/V⁻=±15V, Ta=25°C)

PARAMETER	SYMBOL	TEST CONDITION	MIN.	TYP.	MAX.	UNIT
Input Offset Voltage	V _{IO}	R _S ≤10kΩ	-	0.5	6	mV
Input Offset Current	I _{IO}		-	5	200	nA
Input Bias Current	I _B		-	25	500	nA
Input Resistance	R _{IN}		0.3	5	-	MΩ
Large Signal Voltage Gain	A _V	R _L ≥2kΩ, V _O =±10V	86	100	-	dB
Maximum Output Voltage Swing 1	V _{OM1}	R _L ≥10kΩ	± 12	± 14	-	V
Maximum Output Voltage Swing 2	V _{OM2}	R _L ≥2kΩ	± 10	± 13	-	V
Input Common Mode Voltage Range	V _{ICM}		± 12	14	-	V
Common Mode Rejection Ratio	CMR	R _S ≤10kΩ	70	90	-	dB
Supply Voltage Rejection Ratio	SVR	R _S ≤10kΩ	76.5	90	-	dB
Operating Current	I _{CC}		-	3.5	5.7	mA
Slew Rate						
NJM4558	SR		-	1	-	V/μs
NJM4559	SR		-	2	-	V/μs
Equivalent Input Noise Voltage (note2)	V _{NI}	RIAA, R _S =2.2kΩ, 30kHz LPF	-	1.4	-	μVrms
Gain Bandwidth Product	GB					
NJM4558				3		MHz
NJM4559				6		MHz

(note2) In regard to Noise Standard, NJRC is preparing for special D Rank type products (V_{NI}=1.8μV max.) except for SSOP package.

■ TYPICAL CHARACTERISTICS

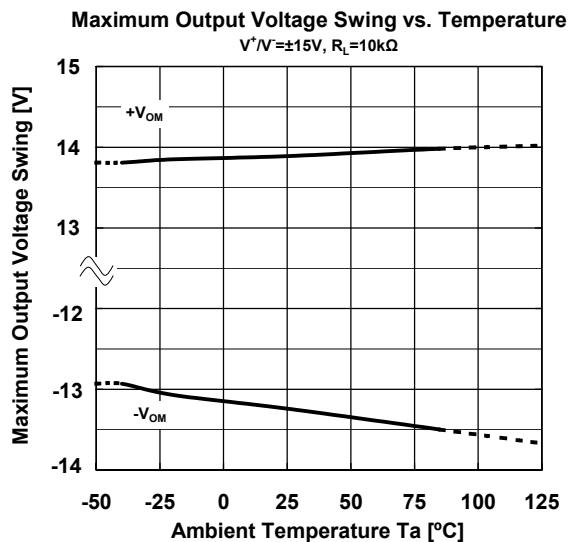
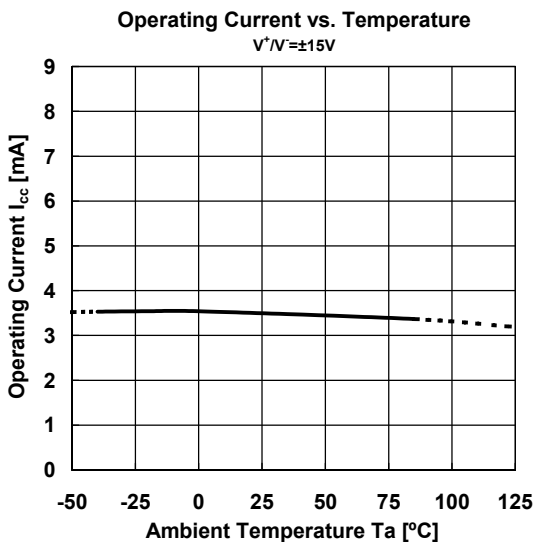
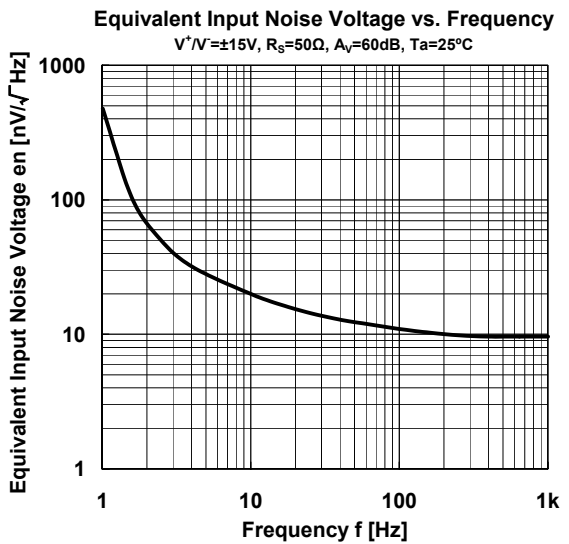
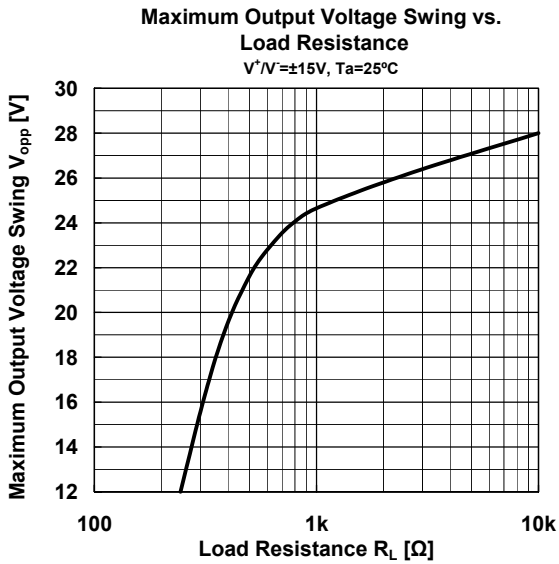
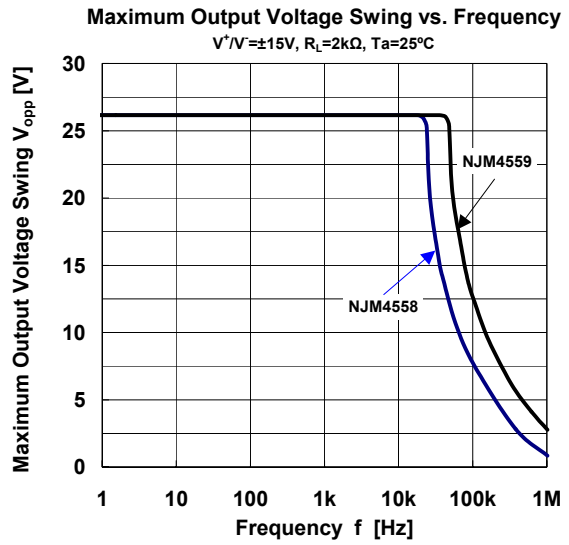
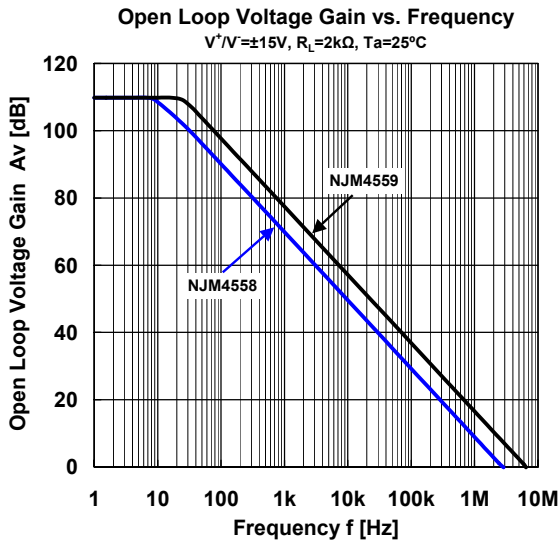

NJM4558/4559

■ TYPICAL CHARACTERISTICS

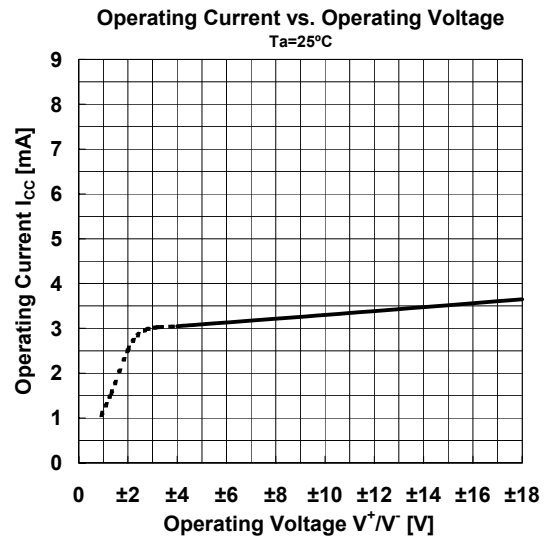
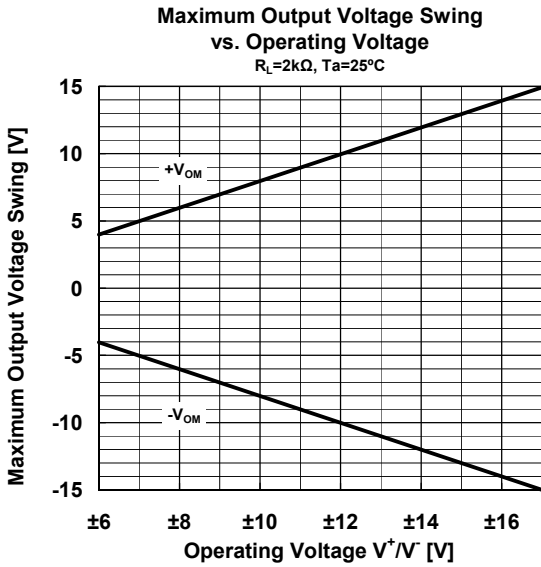
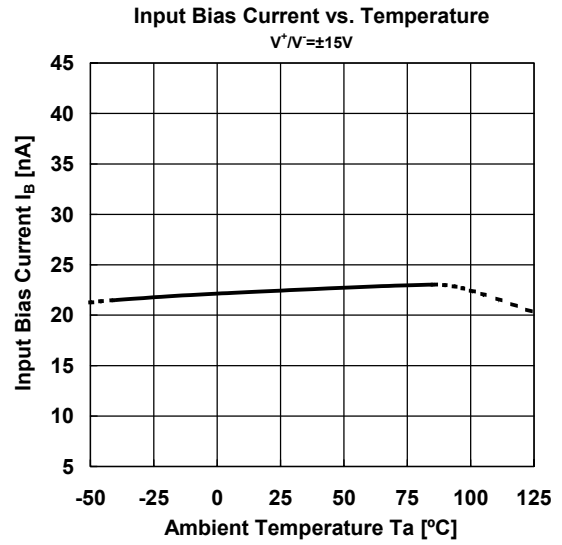
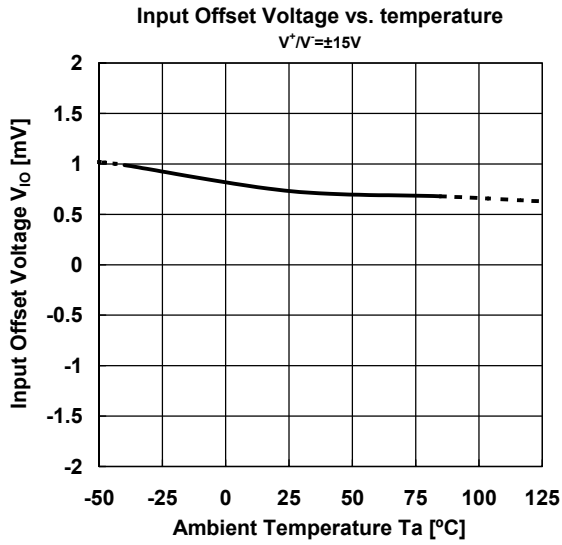

[CAUTION]
 The specifications on this databook are only given for information, without any guarantee as regards either mistakes or omissions. The application circuits in this databook are described only to show representative usages of the product and not intended for the guarantee or permission of any right including the industrial rights.